

# Elite Access

## Robust Facial Recognition Terminal with Ultra-large Capacity and Anti-corrosive Coatings

Compatible with  
**ZKBioSecurity**

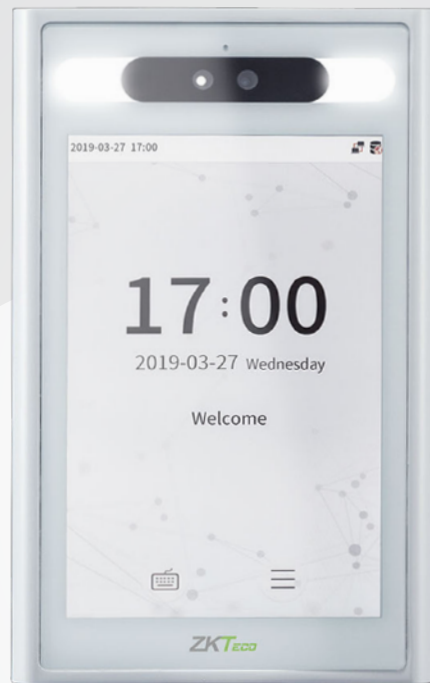

**Elite Access** is a new high-level facial recognition terminal with extremely powerful facial recognition capability supported with ZKTeco's customized powerful CPU and ultra-large capacity of facial templates, a maximum of 50,000 facial templates for 1:N recognition.

With its powerful core and the latest facial recognition algorithm, Elite Access rapidly recognizes a face within 0.3 second, while effectively preventing any kinds of print attack with its strong anti-spoofing algorithm.

Besides, Elite Access is equipped with a 2MP low-light WDR camera and backed by an international standard rating of IP68 and IK04 which guarantees high-quality facial recognition and outdoor durability under challenging lighting conditions (0.5lux - 50,000lux) and extreme weather from -30°C to 60°C.

Elite Access's high corrosion resistance has also been proven so the terminal is suitable for exterior and interior installation environments with different levels of salinity and humidity such as industrial and coastal areas.

## Features

- Ultra-large capacity: 30,000 facial templates (standard) or 50,000 facial templates (optional) for 1:N facial authentication
- Unrivalled facial recognition speed (less than 0.3 seconds per face)
- 2MP starlight CMOS sensor camera with WDR function, which enables the terminal to recognize faces under challenging lighting environment (0.5 lux – 50,000 lux)
- Anti-spoofing algorithm against print attack (laser, color and B/W photos), videos attack, and 3D mask attack
- Smart energy-saving design; a microwave detector will wake up the terminal when it precisely detects the distance between the user and the device is 3 meters (~9.84 feet) or less
- Integrated 125 kHz prox card reader (optional Mifare)
- 8" touchscreen with 400 lux, which offers high visibility under strong and direct light
- Supplement lighting with adjustable brightness
- Multiple communication methods: TCP/IP, RS485, RS232, Wi-Fi (optional)
- IP68 dust-proof and waterproof standard and IK04 vandal-proof standard
- Wide range of working temperature (-30 ~ 60°C; -22 ~ 140°F)
- Consistent and reliable anti-corrosion protection: the plastic part of the terminal was not cracked and the metal part was not corroded after the salt fog test using 5% NaCl of around 6.5-7.2 pH at 35°C for 240 hours

## Specifications ( Green Label Premium Feature)

### Capacity

 <b>Faces:</b>	30,000 (standard) 50,000 (optional)
<b>Users:</b>	50,000
 <b>Transactions:</b>	1,000,000
<b>User Photos:</b>	20,000
<b>Event Photos:</b>	10,000

### Compatibility

Security Relay Box  
Wiegand / RS485 / RS232 Slave Reader  
With FP / RFID / Barcode (optional)  
ZKBioSecurity Software



### Standard Functions

Access Levels, Groups, Holidays, DST  
Duress Mode, Anti-Passback  
Record Query, Custom Wallpaper &  
Screen Saver, Tamper Switch Alarm

### Access Control Interfaces

Lock Relay Output  
Alarm Output / Auxiliary Input  
Exit Button / Door Sensor

### Special Functions

-  IP68 & IK04
-  Corrosion Resistant (GB/T2423.17-2008)
-  0.3s High Speed Facial Recognition
- Alive Body Detection
- HTTPS Encryption (optional)
- Event Snapshot



### Communication

TCP / IP, RS485 / RS232  
Wiegand Input / Output  
Wi-Fi (optional)

### Power

Operating Voltage 12V DC  
Current Draw <2,000mA

### Hardware

-  900MHz Dual Core Customized CPU  
512MB RAM / 8G Flash
-  125KHz EM Reader / 13.56MHZ MF (optional)
- 2MP WDR Low Light Camera
- Hi-Fi Audio
- Microwave Distance Detection Sensor
-  8" High Brightness IPS Touch LCD
- Reset Button & Tamper Switch

### Additional Information

<b>Face Algorithm:</b>	ZKLiveFace 5.8
<b>Working Temperature:</b>	-30°C ~ 60°C (-22°F ~ 140°F)
<b>Working Humidity:</b>	≤93%
<b>Storage Temperature:</b>	-40°C ~ +65°C (-40°F ~ +149°F)
<b>Storage Humidity:</b>	≤93%
<b>Net Weight:</b>	1,483g
<b>Dimensions (H*L*D):</b>	245.6*144*25.0mm

## Wiring Diagram

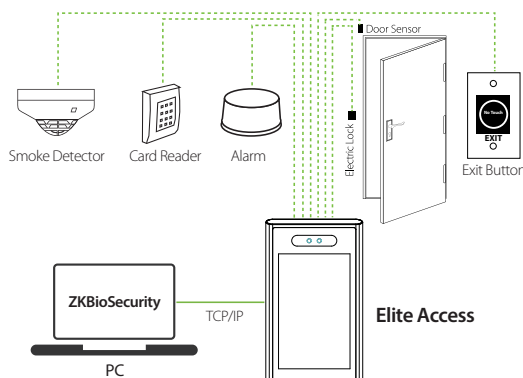

## Dimensions (mm)

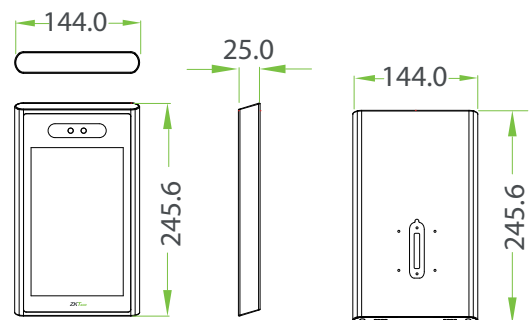

V1.0 2020.02.20